

**ULTREX**

**Electric  
Ice Cream Maker**

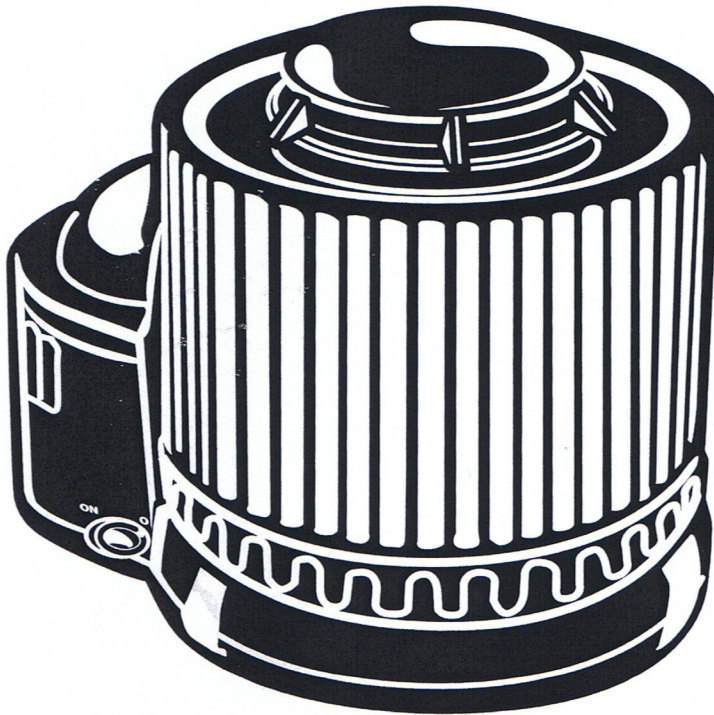

**Instruction Book**

---

MODEL 14009

# **IMPORTANT SAFEGUARDS**

*WHEN USING ELECTRICAL APPLIANCES, BASIC SAFETY PRECAUTIONS SHOULD ALWAYS BE FOLLOWED, INCLUDING THE FOLLOWING:*

1. Read all instructions carefully.
2. Do not touch hot surfaces. Use handles or knobs.
3. To protect against electrical shock, do not immerse motor base in water or other liquid.
4. Close supervision is necessary when any appliance is used by or near children.
5. Unplug from outlet when not in use, before putting on or taking off parts, and before cleaning.
6. Avoid contacting moving parts.
7. Do not operate any appliance with a damaged cord or plug, or after the appliance malfunctions or is dropped or damaged in any manner. Return appliance to the nearest authorized service facility for examination, repair or electrical or mechanical adjustment.
8. The use of attachments not recommended or sold by the manufacturer may cause fire, electric shock or injury.
9. Do not use outdoors.
10. Do not let cord hang over edge of table or counter, or touch hot surfaces.
11. SAVE THESE INSTRUCTIONS.

**SAVE THESE INSTRUCTIONS  
FOR HOUSEHOLD USE ONLY**

2

A short power-supply cord has been provided to reduce the risks resulting from entanglement or tripping over a long cord.

An extension cord may be used if care is exercised in their use.

If an extension cord is used, the marked electrical rating of the extension cord should be at least as great as the electrical rating of the appliance. Arrange the longer cord so that it will not drape over the counter top or table top where it can be pulled on by children or tripped over.

**NOTE: This appliance has a polarized plug (one blade is wider than the other). As a safety feature, this plug will fit in a polarized outlet only one way. If the plug does not fit fully in the outlet, reverse the plug. If it still does not fit, contact a qualified electrician. Do not attempt to modify the plug in any way.**

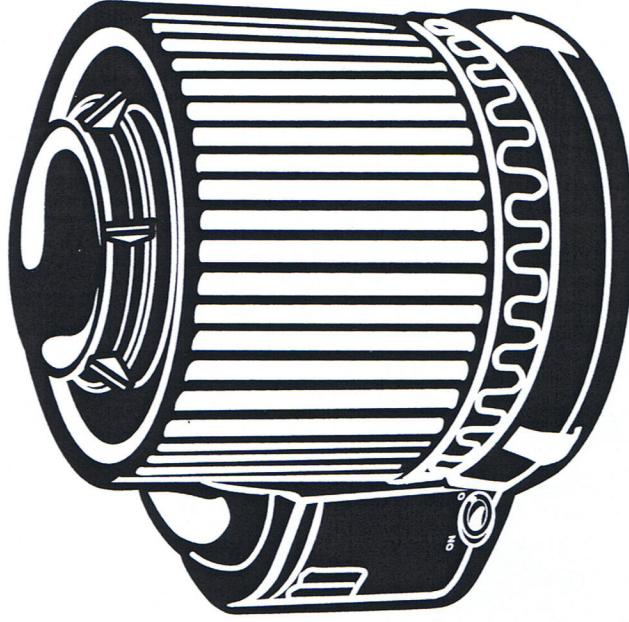

3



## **FEATURES**

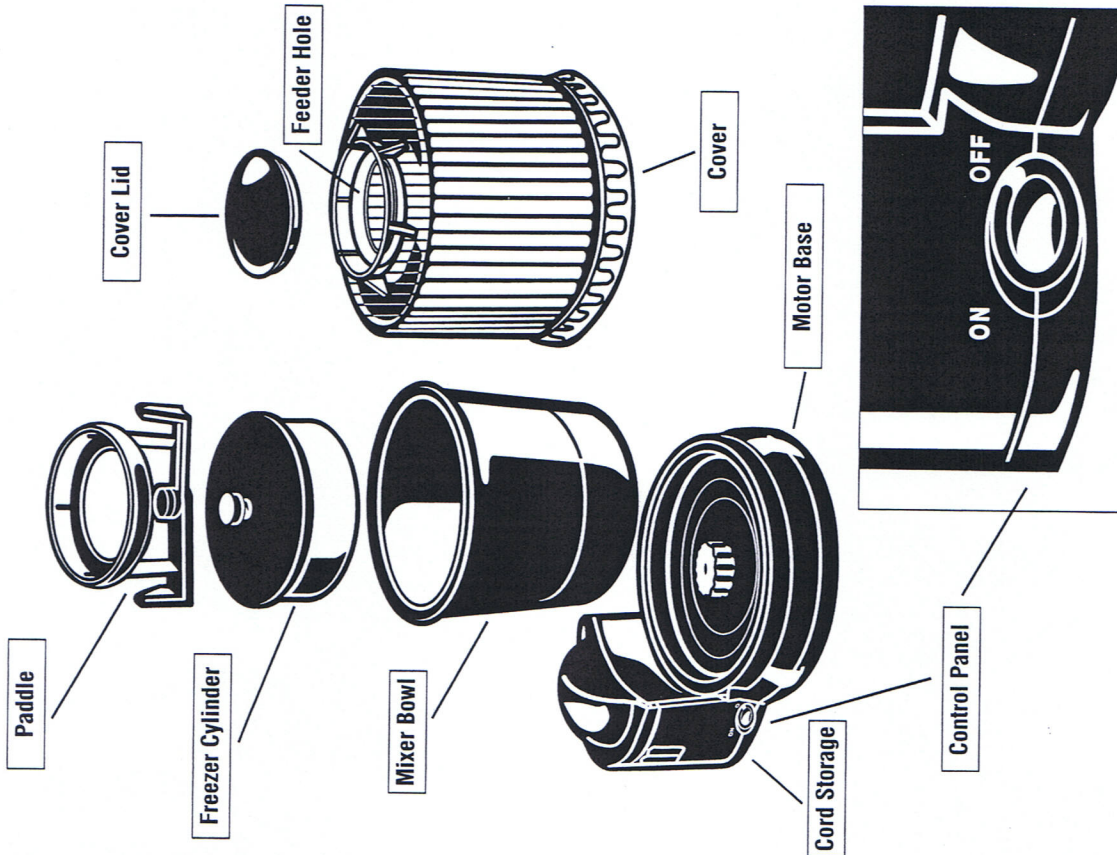

4

## **BEFORE FIRST USE**

Before using your Electric Ice Cream Maker for the first time, all pieces of the appliance, **EXCEPT THE MOTOR BASE**, should be washed in warm, soapy water, rinsed and dried thoroughly. **MOTOR BASE IS NOT IMMERSIBLE.** Wash the Motor Base with a damp rag. **NEVER ATTEMPT TO WIPE CLEAN THE ELECTRIC MOTOR BASE WHILE PLUGGED INTO AN ELECTRIC WALL OUTLET.**

## **ASSEMBLY AND USE**

After you have followed the instructions in the "Before First Use" section above, you are ready to assemble and use your Electric Ice Cream Maker.

### **FREEZING THE FREEZER CYLINDER**

**DO NOT** freeze the Freezer Cylinder while still wet. Freezer Cylinder must be completely dry before use.

1. Wrap the Freezer Cylinder in plastic wrap or a plastic bag to help protect the Freezer Cylinder from freezer burn.
2. Place the plastic wrapped Freezer Cylinder upright (as it would be assembled in the Ice Cream Freezer, See Illustration Below) in the back of the freezer. This is where the freezer compartment is the coldest.
3. Allow the liquid contained in the Freezer Cylinder to completely freeze. When shaken, you should not be able to hear any liquid moving inside.

Freezing times can range from 6 to 22 hours depending on your freezer temperature. These times are based on freezer temperatures from  $-30^{\circ}\text{C}/-22^{\circ}\text{F}$  to  $-10^{\circ}\text{C}/-14^{\circ}\text{F}$ . For quick frozen desserts anytime, it is suggested that you store your Freezer Cylinder in the freezer at all times. When you want to use your Ice Cream Maker, simply pull the frozen Freezer Cylinder out of the freezer and it is ready to use.

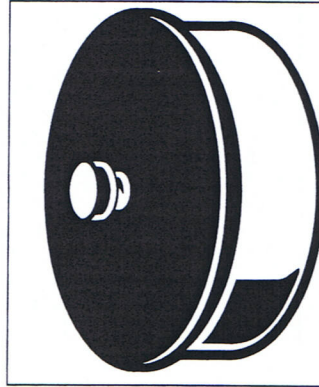

**FREEZER CYLINDER  
SHOWN IN UPRIGHT POSITION**

5

## **ASSEMBLY AND USE (CONT.)**

### **ASSEMBLING AND USING THE ICE CREAM MAKER**

#### **STEP ONE:**

Follow recipe directions on how to make ice cream. You can choose any recipe as long as it does not exceed 1 quart. See suggested recipes on pages 9-11.

#### **STEP ONE:**

Place Motor Base on a clean, flat surface. (See Illustration A)

#### **STEP TWO:**

Set the Mixer Bowl on top of the Motor Base, fitting the Motor Base Gear inside the Gear Insert space (See Illustration B) on the bottom of the Mixer Bowl.

#### **STEP THREE:**

Place the frozen Freezer Cylinder inside the Mixer Bowl. (See Illustration C) Freezer Cylinder should not be removed from the freezer until you are ready to use and ice cream recipe has been prepared. Cylinder begins defrosting as soon as it comes out of the freezer.

#### **STEP FOUR:**

Set the Paddle on top of the Freezer Cylinder, placing the peg on the Freezer Cylinder inside the peg hole on the Paddle. (See Illustration D)

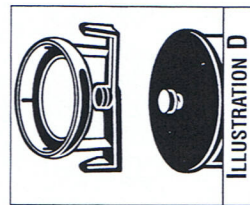
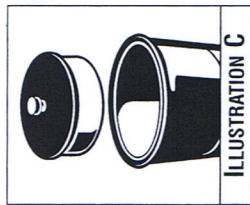
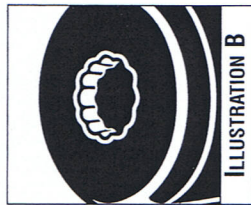
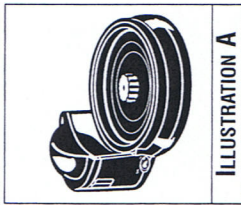

## **ASSEMBLY AND USE (CONT.)** **ASSEMBLING AND USING THE ICE CREAM MAKER (CONT.)**

#### **STEP FIVE:**

Place the Cover over the top of the Mixer Bowl, locking into the grooves on the Motor Base. (See Illustration E on Page 7)

#### **STEP SIX:**

Plug the Electric Cord into the wall electric outlet and turn the On/Off Switch to "On". Mixer Bowl and Freezer Cylinder will begin turning. (See Illustration F)

#### **STEP SEVEN:**

Immediately pour the ice cream mixture through the Feeder Hole of Cover and place the Lid on the Cover. (See Illustration G)

#### **STEP EIGHT:**

You will need to run the Ice Cream Machine for 20 to 40 minutes or until mixture becomes frozen. **DO NOT** shut the machine off while you are making ice cream, it is important that the Mixer Bowl and the Freezer Cylinder continue rotating during the operation. You will not have the same consistency with homemade ice cream as you do with hard ice cream purchased at a supermarket. The ice cream will be frozen, yet still remain a soft-serve consistency. If you desire a harder ice cream, turn the ice cream maker "Off" and spoon the ice cream from the ice cream maker into an air tight, sealable container using a wooden spoon or rubber spatula. Seal and place the air tight container into the freezer.

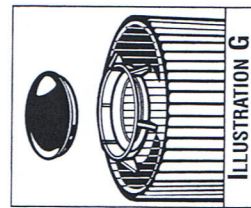
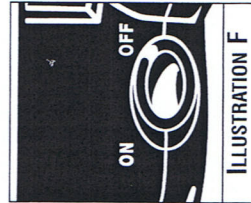
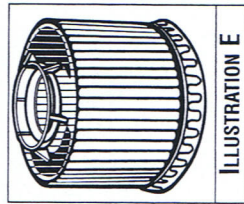



### **SERVING ICE CREAM**

Turn the unit to "Off" and unplug the Motor Base from the electric wall outlet. To serve the ice cream, remove the Lid from the Cover. If the Mixer Bowl has a little excess ice cream, remove it with a rubber spatula or wooden spoon and place in separate bowl. Remove the Cover and serve the ice cream, scooping it out with a rubber spatula or wooden spoon. If ice cream is frozen before you are ready to serve, follow steps above for excess ice cream, remove the Cover and place the Mixer Bowl in the freezer. **DO NOT leave the Mixer Bowl in the freezer over 30 minutes.** If you need to freeze the ice cream for a longer period of time, remove the ice cream from the Mixer Bowl and place in an airtight, sealable container for freezer storage.

### **CARE AND CLEANING**

1. Unplug unit from wall outlet.
2. All parts of the Ice Cream Maker, **EXCEPT THE MOTOR BASE**, are immersible and can be washed in warm soapy water. These parts are also dishwasher safe. However, hand washing is recommended in place of harsh dishwasher detergents over a long period of time. **DO NOT IMMERS THE MOTOR BASE IN WATER OR ANY OTHER LIQUID. DO NOT PLACE FREEZER CYLINDER IN THE DISHWASHER AT ANY TIME.**
3. All parts should be dried thoroughly before storing.

**NEVER PLACE THE FREEZER CYLINDER IN THE FREEZER WET. IT MUST BE COMPLETELY DRY BEFORE BEING PLACED IN THE FREEZER.**

### **CORD STORAGE**

Loosely wrap cord and place in the Cord Storage area in the bottom of the Motor Base.

Cord Storage

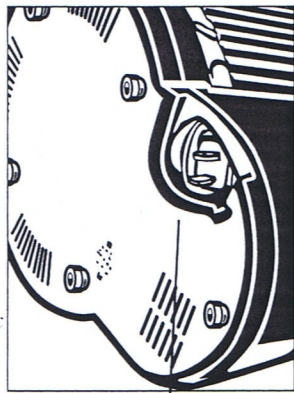

### **STORING YOUR ELECTRIC ICE CREAM MAKER**

Unit can be stored in its original box in a clean, dry place. Make sure unit is clean and thoroughly dry before storing. **DO NOT** store on the countertop with the Motor Base plugged into the electric wall outlet. Unplug the unit when not in use.

### **ICE CREAM RECIPES**

**NOTE: BECAUSE OF HEALTH WARNINGS GIVEN REGARDING THE EATING OF RAW EGGS, WE STRONGLY SUGGEST THAT PASTEURIZED EGG BEATERS OR EGG SUBSTITUTES, WHICH CAN BE FOUND IN YOUR GROCER'S REFRIGERATOR CASE, BE SUBSTITUTED FOR RAW EGGS. SUBSTITUTION MEASUREMENTS CAN BE FOUND ON THE BACK OF THESE PACKAGES.**

#### **VANILLA ICE CREAM**

- 1/2 cup sugar
- 1 1/4 cups half and half
- 1 1/2 cups heavy whipping cream
- 2 eggs (or egg substitute - see package for substitution details)
- 2 tsp. vanilla

Using an electric mixer, beat eggs and sugar until thick and cream-colored. Add half and half, cream and vanilla, mixing well. Yields approximately 1 quart. Follow directions for freezing.

## **ICE CREAM RECIPES (CONT.)**

### **CHOCOLATE ICE CREAM**

- 1/2 cup sugar
- 1 1/4 cups half and half
- 1 1/4 cups heavy whipping cream
- 3 egg yolks
- 1 tsp. vanilla
- 1/4 cup unsweetened cocoa

By hand using a whisk, beat half and half and egg yolks together. Place in saucepan over medium heat, stirring constantly, until the mixture is thick enough to coat a spoon. Remove from heat and add cocoa. Using a whisk, beat the cocoa thoroughly with the hot mixture. Cool. Add cream and vanilla, mixing well. Refrigerate overnight. Yields approximately 1 quart. Follow directions for freezing.

### **VARIATIONS FOR VANILLA AND CHOCOLATE ICE CREAM**

**PEANUT BUTTER CHUNKS:** Spread 1 cup of peanut butter onto wax paper on a cookie sheet about 1/4" thick. Place the cookie sheet in the freezer and freeze until solid. Remove wax paper to a cutting board and quickly chop up peanut butter into chunks. After you have poured your ice cream mixture into the Ice Cream Freezer, add the peanut butter chunks.

**CHOCOLATE CHIP OR CANDY PIECES:** Pour your ice cream mixture into the Ice Cream Freezer and add 1/2 to 3/4 cup chocolate chips or candy pieces to the mixture.

**FRUIT PIECES:** Pour your ice cream mixture into the Ice Cream Freezer and add 1/2 to 3/4 cup cut up fruit pieces such as strawberries, peaches, bananas, etc. If using frozen fruit, be sure to unthaw fruit before adding to the Ice Cream Maker.

## **RECIPES (CONT.)**

### **OTHER SUGGESTED USES FOR YOUR ICE CREAM MAKER**

Your Ice Cream Maker can be used for more than just ice cream. Any recipe can be used, just remember to make only 1 quart at a time.

MARGARITA'S  
DAIQUIRI'S  
PINA COLADA'S  
FROZEN ICE  
FROZEN FRUIT SMOOTHIES  
SORBET  
SHERBET  
YOGURT

### **3 YEAR LIMITED WARRANTY**

*Innova, Inc. electric cookware products are warranted to be free from defects in material and workmanship under normal household use for a period of 3 years from date of original purchase.*

*During this period, Innova, Inc. will repair or replace, at its option, any defective item returned to the address below, transportation prepaid.*

*This warranty does not cover molded phenolic handles and knobs, nor does it cover damage resulting from misuse, abuse, negligence, accidents, overheating, improper repair, and commercial use.*

*This warranty gives you specific legal rights, and you may also have other rights which vary from state to state.*

### **REPLACEMENT PARTS**

Do not use replacement parts not supplied by INNOVA, INC.. To request information and prices on replacement parts, contact:

**INNOVA, INC.**  
**409 West 76th Street**  
**Davenport, Iowa 52806**  
**Phone: (800)767-5160**  
**Fax: (319)388-9963**

### **REPLACEMENT PARTS LIST**

#### **DESCRIPTION**

Cover Lid  
Cover  
Paddle  
Freezer Cylinder  
Mixer Bowl  
Motor Base

Made in China  
©2001

Printed in China